

Pedestal gas rise 435-605 base Ø305 column Ø87

MAIN PRODUCT MATERIALS:

- COLUMN AND BASE MADE OF HIGH GRADE POLISHED AND ANODISED ALUMINUM;
- SYNTHETIC END CAPS, KNOB(S) AND HANDLE(S).

MAIN SPECIFICATIONS:

- 360 DEG. ROTATABLE SWIVEL/ SLIDE;
- SLIDE TRAVELS THROUGH 127mm IN TOTAL AND LOCKABLE IN 1 OF 7 POSITIONS;
- HEIGHT ADJUSTABLE, ASSISTED BY A 400N (40,8KG) GAS SPRING.

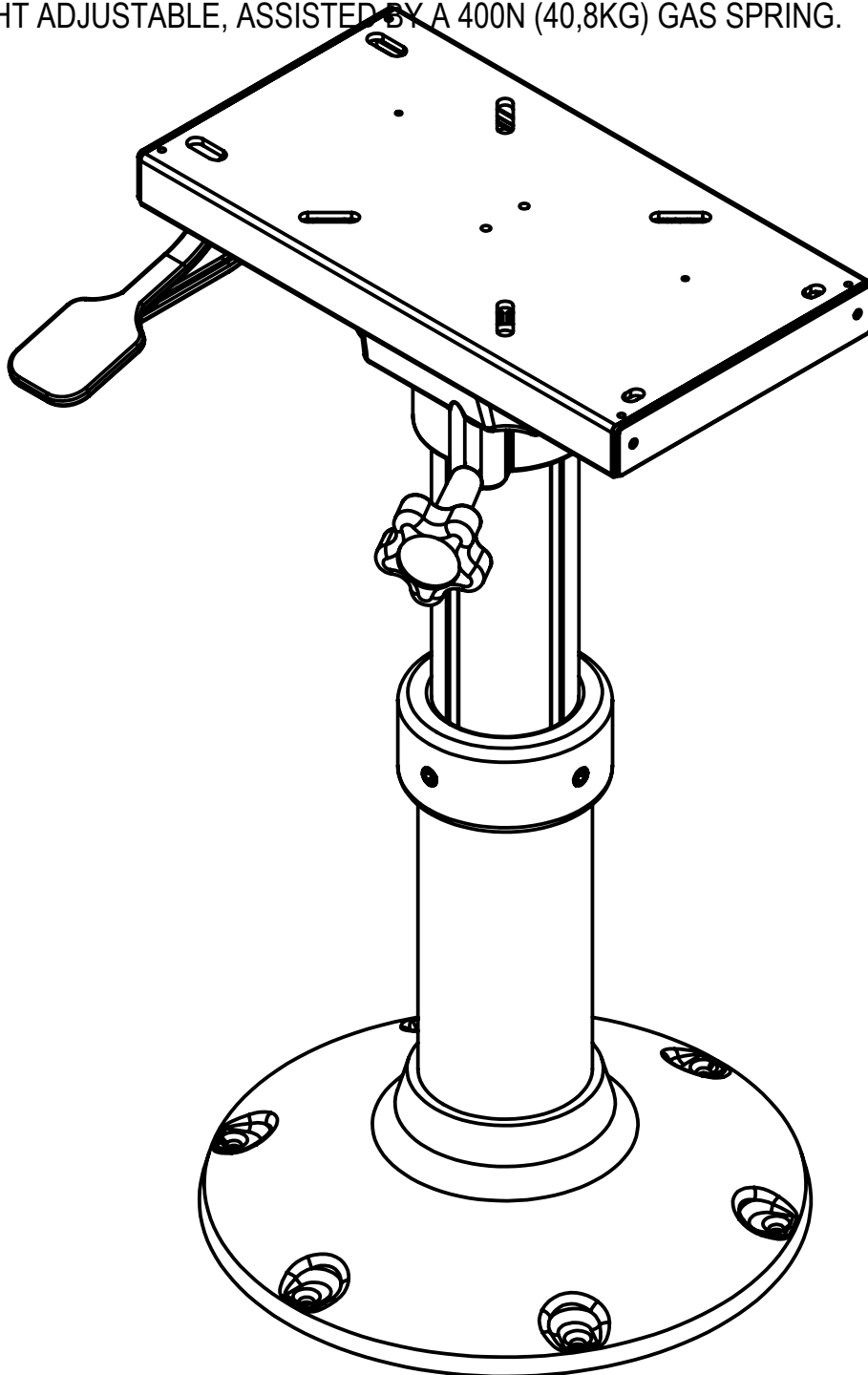

MEETS OR EXCEEDS LOAD TESTS TESTED ACCORDING TO ABYC H31-9:

- LOAD = 204KG (STATIC);
- LOAD = 102KG (DYNAMIC).
- NO SPARE PARTS AVAILABLE.

Pedestal gas rise 435-605 base Ø305 column Ø87

